

Article number: 203250M850A1S

Description: E+G levelling foot  
GN 32-50-M8-50-A1-S

Note: S Without nut, External hexagon at the bottom

## Measures

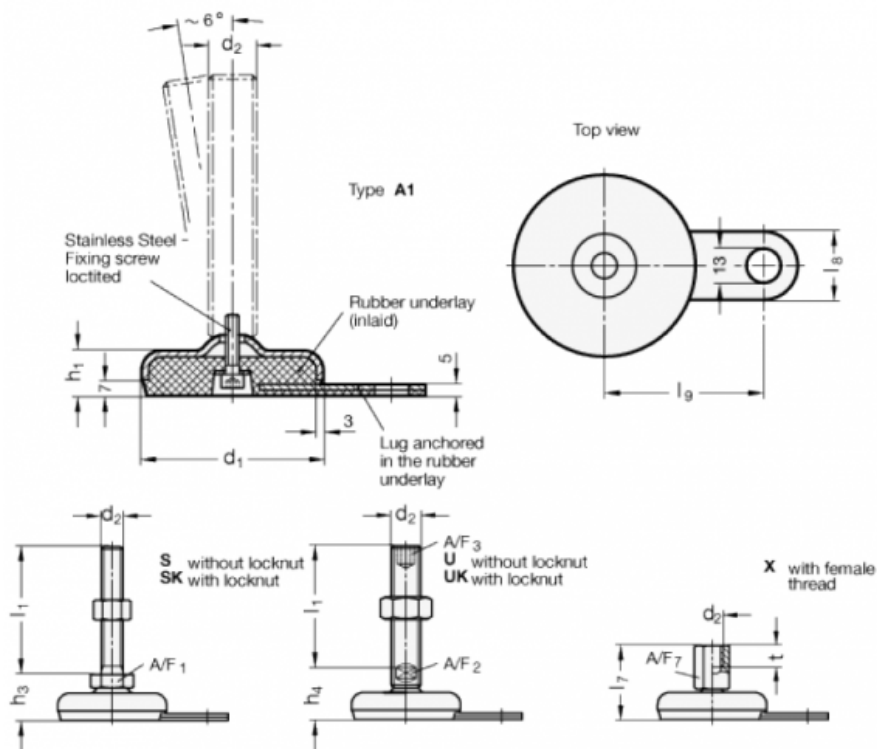

A/F1	= 17
d1	= 50
d2	= M8
h1	= 18
h3	= 26
l1	= 50
l8	= 25
l9	= 45